



**Features**

- High current operation for greater luminous output
- Low power consumption and thermal resistance
- Can be used with automatic insertion equipment
- RoHS Compliant



**Benefits:**

- Rugged design allows for easy maintenance
- Robust package for optimum reliability

**Typical Applications:**

- Automotive side markers
- Gaming and entertainment lighting
- Signs and road hazard indicators

**Package Schematics**

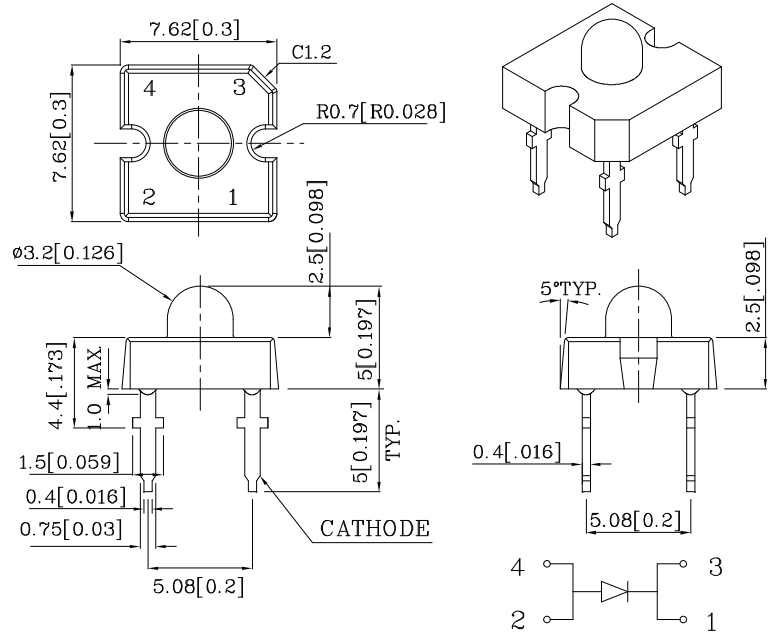

**Notes:**

1. All dimensions are in millimeters (inches).
2. Tolerance is  $\pm 0.25(0.01)$  unless otherwise noted.
3. Specifications are subject to change without notice.

Absolute Maximum Ratings ( $T_A=25^\circ\text{C}$ )		M2ACR (AlGaInP)	Unit
Reverse Voltage	$V_R$	5	V
DC Forward Current	$I_F$	70	mA
Power Dissipation	$P_D$	210	mW
Operating Temperature	$T_A$	-40 ~ +85	°C
Storage Temperature	$T_{stg}$	-55 ~ +85	
Lead Solder Temperature [1.5mm(0.06inch)Below Seating Plane.[1]		260°C For 5 Seconds	

1.No Reflow soldering .

Operating Characteristics ( $T_A=25^\circ\text{C}$ )		M2ACR (AlGaInP)	Unit
Forward Voltage (Min.) ( $I_F=70\text{mA}$ )	$V_F$	2.2	V
Forward Voltage (Typ.) ( $I_F=70\text{mA}$ )	$V_F$	2.4	V
Forward Voltage (Max.) ( $I_F=70\text{mA}$ )	$V_F$	3.0	V
Reverse Current (Max.) ( $V_R=5\text{V}$ )	$I_R$	10	$\mu\text{A}$
Wavelength of Peak Emission CIE127-2007* (Typ.) ( $I_F=70\text{mA}$ )	$\lambda_P$	640*	nm
Wavelength of Dominant Emission CIE127-2007* (Typ.) ( $I_F=70\text{mA}$ )	$\lambda_D$	625*	nm
Spectral Line Full Width At Half Maximum (Typ.) ( $I_F=70\text{mA}$ )	$\Delta\lambda$	25	nm
Capacitance (Typ.) ( $V_F=0\text{V}$ , $f=1\text{MHz}$ )	C	27	pF
Thermal Resistance (Typ.)	$R_{\theta j-pin}$	125	°C/W

Part Number	Emitting Color	Emitting Material	Lens-color	Luminous Intensity CIE127-2007* ( $I_F=70\text{mA}$ ) cd		Luminous Flux CIE127-2007* ( $I_F=70\text{mA}$ ) lm	Wavelength CIE127-2007* $\lambda_P$ nm	Viewing Angle 2 $\theta$ 1/2
				min.	typ.	typ.		
XSM2ACR783W	Red	AlGaInP	Water Clear	12 7*	21.99 13*	6*	640*	30°

1.Luminous intensity is measured with an integrating sphere after the device has stabilized.

2. $\theta$  1/2 is the angle from optical centerline where the luminous intensity is 1/2 of the optical peak value.

3. LEDs are binned according to their Luminous intensity.

\* Luminous intensity / luminous flux value and wavelength are in accordance with CIE127-2007 standards.

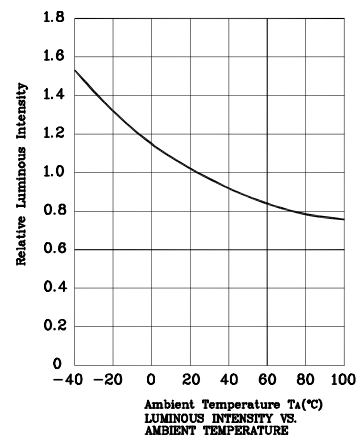
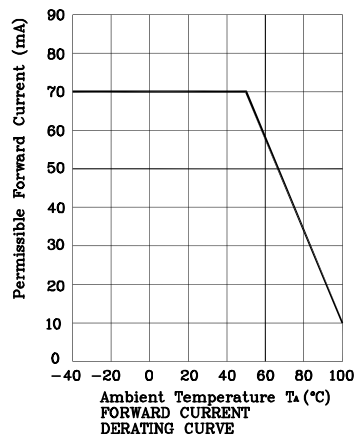
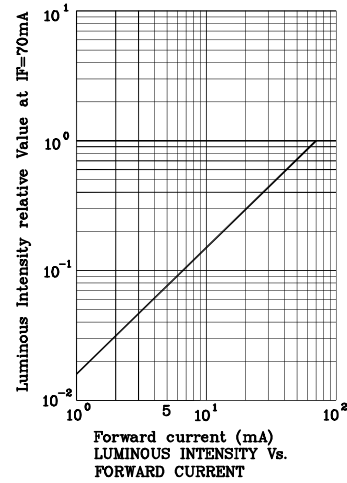
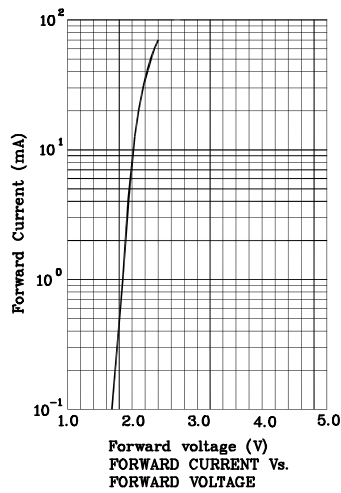
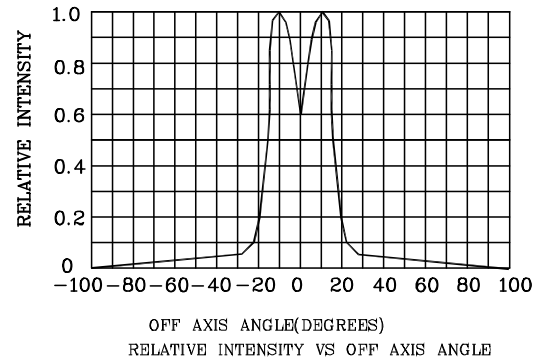
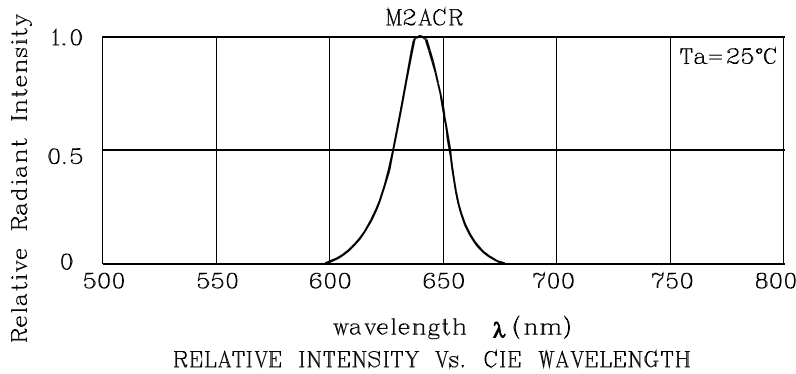

Wave Soldering Profile For Thru-Hole Products (Pb-Free Components)

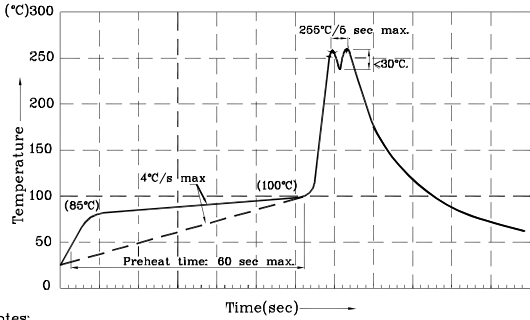

- Notes:
1. Recommend pre-heat temperature of 105°C or less (as measured with a thermocouple attached to the LED pins) prior to immersion in the solder wave with a maximum solder bath temperature of 260°C
  2. Peak wave soldering temperature between 245°C ~ 255°C for 3 sec (5 sec max).
  3. Do not apply stress to the epoxy resin while the temperature is above 85°C.
  4. Fixtures should not incur stress on the component when mounting and during soldering process.
  5. SAC 305 solder alloy is recommended.
  6. No more than one wave soldering pass.

Remarks:

If special sorting is required (e.g. binning based on forward voltage, luminous intensity / luminous flux, or wavelength), the typical accuracy of the sorting process is as follows:

1. Wavelength: +/-1nm
2. Luminous Intensity / Luminous Flux: +/-15%
3. Forward Voltage: +/-0.1V

Note: Accuracy may depend on the sorting parameters.

PACKING & LABEL SPECIFICATIONS

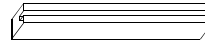
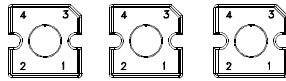

75PCS / IC TUBE(520x8.3x15mm)

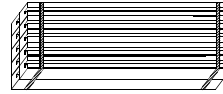

750pcs / 10pcs IC TUBE

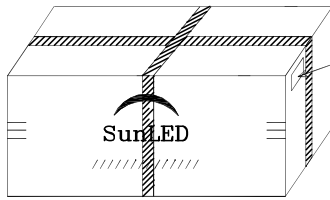

7.5K / BOX

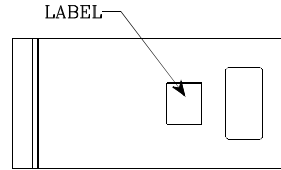

10pcs IC TUBE / Bag



Q.C. Q C

XX XX XXXX

PASSED

P/NO : XSxxx783x	
QTY : 750 pcs	CODE: XXX
S/N : XX	
LOT NO:	
 xxxxxxxxxxxxxxxxxxxxxxxx	
RoHS Compliant	