

Features

- Housing material: Type 66 Nylon
- Black casing provides superior contrast
- Housing UL rating: 94V-0
- Reliable & robust
- Custom color combinations available
- 5V internal resistor
- RoHS Compliant

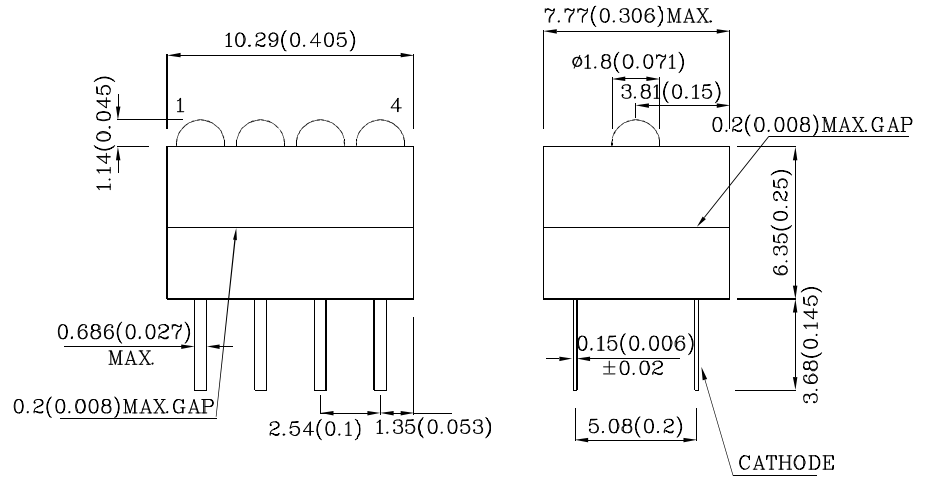

Package Schematics



Notes:

1. All dimensions are in millimeters (inches).
2. Tolerance is $\pm 0.25(0.01)$ unless otherwise noted.
3. Specifications are subject to change without notice.

Absolute Maximum Ratings ($T_A=25^\circ\text{C}$)		UR (GaAsP/GaP)	Unit
Reverse Voltage	V_R	5	V
Forward Voltage	V_F	6	V
Power Dissipation	P_D	85	mW
Operating Temperature	T_A	-40 ~ +70	°C
Storage Temperature	T_{stg}	-40 ~ +85	
Lead Solder Temperature [2mm Below Package Base]	260°C For 3 Seconds		
Lead Solder Temperature [5mm Below Package Base]	260°C For 5 Seconds		

Operating Characteristics ($T_A=25^\circ\text{C}$)		UR (GaAsP/GaP)	Unit
Forward Current (Typ.) ($V_F=5\text{V}$)	I_F	13	mA
Forward Current (Max.) ($V_F=5\text{V}$)	I_F	17.5	mA
Reverse Current (Max.) ($V_R=5\text{V}$)	I_R	10	uA
Wavelength of Peak Emission (Typ.) ($V_F=5\text{V}$)	λ_P	627	nm
Wavelength of Dominant Emission (Typ.) ($V_F=5\text{V}$)	λ_D	625	nm
Spectral Line Full Width At Half-Maximum (Typ.) ($V_F=5\text{V}$)	$\Delta\lambda$	45	nm

Part Number	Emitting Color	Emitting Material	Lens-color	Luminous Intensity ($V_F=5\text{V}$) med		Wavelength nm λ_P	Viewing Angle 2 θ 1/2
				min.	typ.		
XNG4ZUR46D5V	Red	GaAsP/GaP	Red Diffused	4	11	627	40°

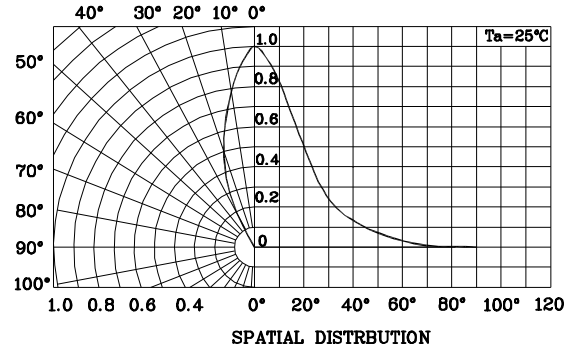
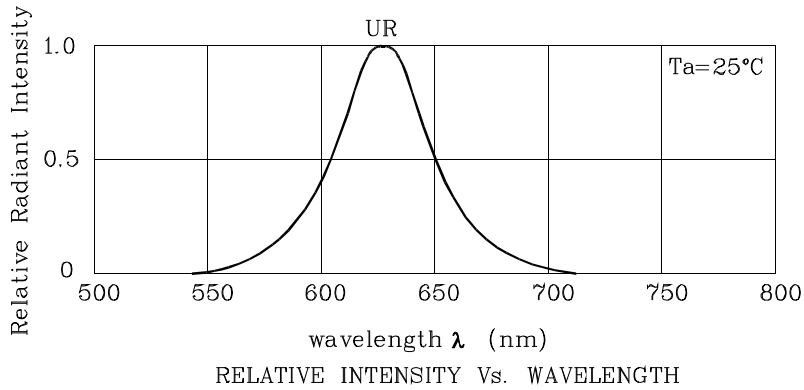

❖ UR

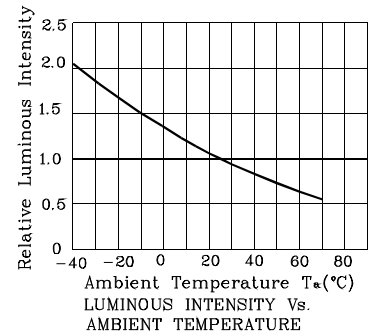
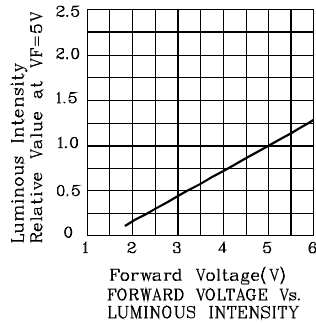
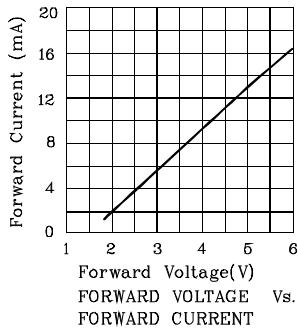

Wave Soldering Profile for Thru-Hole Products (Pb-Free Components)

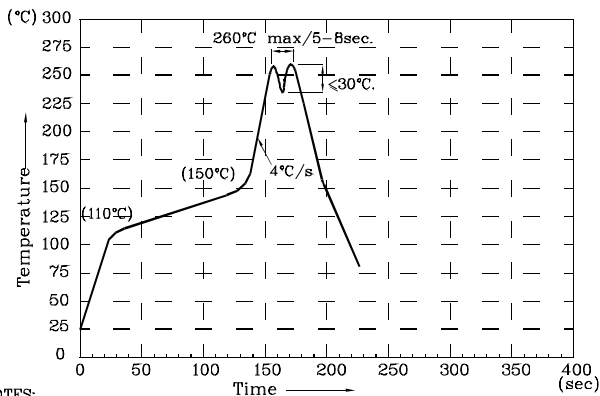

NOTES:

1. Recommend the wave temperature 245°C~260°C. The maximum soldering temperature should be less than 260°C.
2. Do not apply stress on epoxy resins when temperature is over 85°C.
3. The soldering profile apply to the lead free soldering (Sn/Cu/Ag alloy).
4. During wave soldering, the PCB top-surface temperature should be kept below 105°C.
5. No more than once.

Remarks:

If special sorting is required (e.g. binning based on Luminous intensity/ luminous flux, or wavelength), the typical accuracy of the sorting process is as follows:

1. Wavelength: +/-1nm
2. Luminous intensity/ luminous flux: +/-15%

Note: Accuracy may depend on the sorting parameters.

PACKING & LABEL SPECIFICATIONS

