

**Features**

- Low power consumption
- Robust package
- I.C. Compatible
- Standard configuration: Gray face w/ white segments
- Optional black face provides superior color contrast
- RoHS Compliant

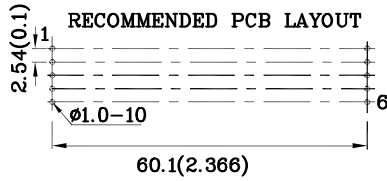

**Package Schematics**

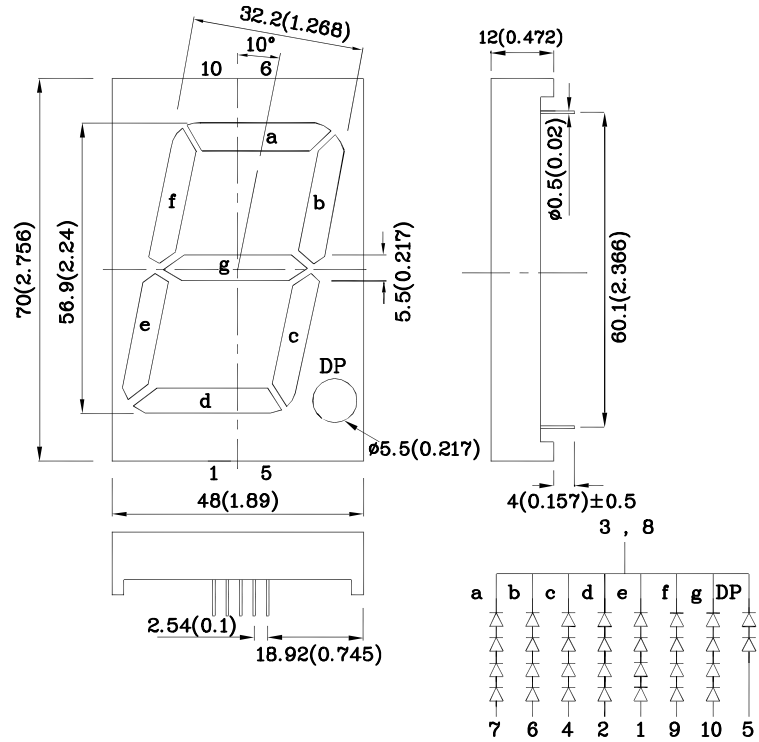

Notes:

1. All dimensions are in millimeters (inches), Tolerance is  $\pm 0.25(0.01)$  unless otherwise noted.
2. Specifications are subject to change without notice.

Absolute Maximum Ratings ( $T_A=25^\circ\text{C}$ )		UY (GaAsP/GaP)	Unit
Reverse Voltage Per Segment Or (Dp)	$V_R$	5	V
Forward Current Per Segment Or (Dp)	$I_F$	30	mA
Forward Current (Peak) 1/10 Duty Cycle 0.1ms Pulse Width Per Segment Or (Dp)	$i_{FS}$	140	mA
Power Dissipation Per Segment Or (Dp)	$P_D$	300 (150)	mW
Operating Temperature	$T_A$	-40 ~ +85	°C
Storage Temperature	$T_{stg}$	-40 ~ +85	
Lead Solder Temperature [2mm Below Package Base]	260°C For 3-5 Seconds		

Operating Characteristics ( $T_A=25^\circ\text{C}$ )		UY (GaAsP/GaP)	Unit
Forward Voltage (Typ.) ( $I_F=10\text{mA}$ ) Per Segment Or (Dp)	$V_F$	7.8 (3.9)	V
Forward Voltage (Max.) ( $I_F=10\text{mA}$ ) Per Segment Or (Dp)	$V_F$	10 (5.0)	V
Reverse Current (Max.) ( $V_R=5\text{V}$ ) Per Segment Or (Dp)	$I_R$	10	$\mu\text{A}$
Wavelength of Peak Emission (Typ.) ( $I_F=10\text{mA}$ )	$\lambda_P$	590	nm
Wavelength of Dominant Emission (Typ.) ( $I_F=10\text{mA}$ )	$\lambda_D$	588	nm
Spectral Line Full Width At Half-Maximum (Typ.) ( $I_F=10\text{mA}$ )	$\Delta\lambda$	35	nm
Capacitance (Typ.) ( $V_F=0\text{V}$ , $f=1\text{MHz}$ )	C	20	pF

Part Number	Emitting Color	Emitting Material	Luminous Intensity ( $I_F=10\text{mA}$ ) ucd		Wavelength nm $\lambda_P$	Description
			min.	typ.		
XDUY57C	Yellow	GaAsP/GaP	21000	39990	590	Common Cathode, Rt.Hand Decimal

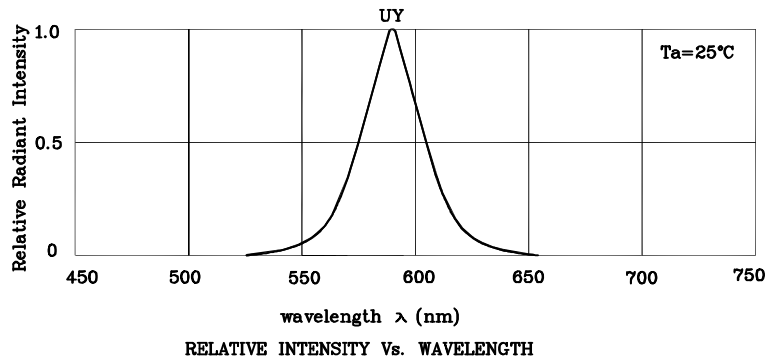

❖ UY

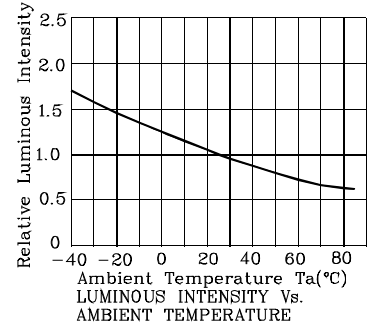
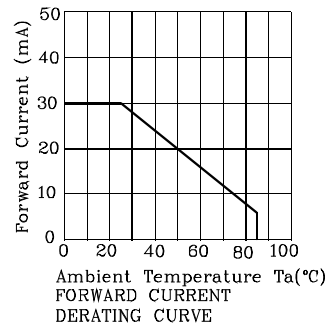
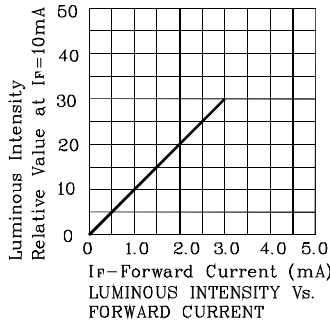
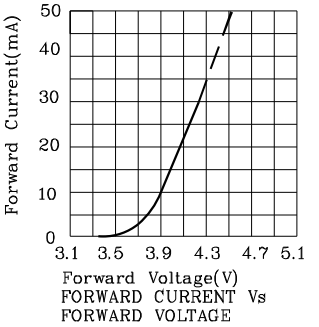
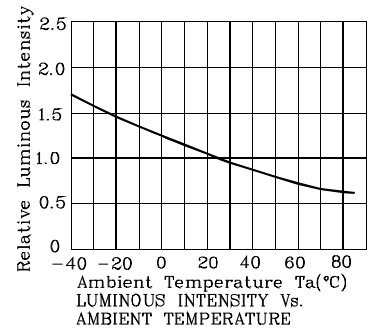
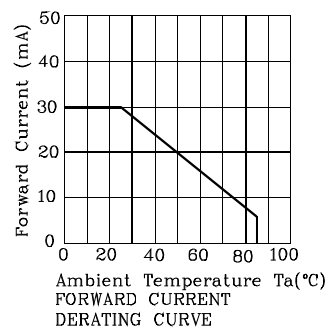
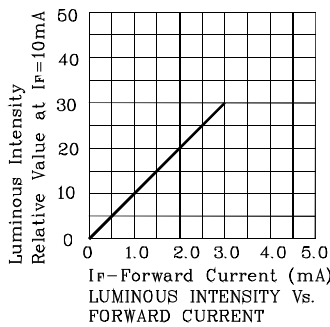
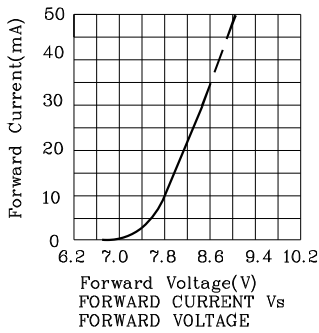

Wave Soldering Profile for Thru-Hole Products (Pb-Free Components)

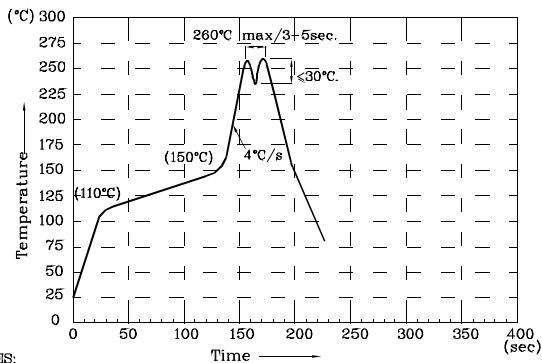

NOTES:

1. Recommend the wave temperature 245°C~260°C. The maximum soldering temperature should be less than 260°C.
2. Do not apply stress on epoxy resins when temperature is over 85°C.
3. The soldering profile apply to the lead free soldering (Sn/Cu/Ag alloy).
4. During wave soldering, the PCB top-surface temperature should be kept below 105°C.
5. No more than once.

Remarks:

If special sorting is required (e.g. binning based on forward voltage, luminous intensity / luminous flux, or wavelength),

the typical accuracy of the sorting process is as follows:

1. Wavelength: +/-1nm
2. Luminous Intensity / Luminous Flux: +/-15%
3. Forward Voltage: +/-0.1V

Note: Accuracy may depend on the sorting parameters.



PACKING & LABEL SPECIFICATIONS

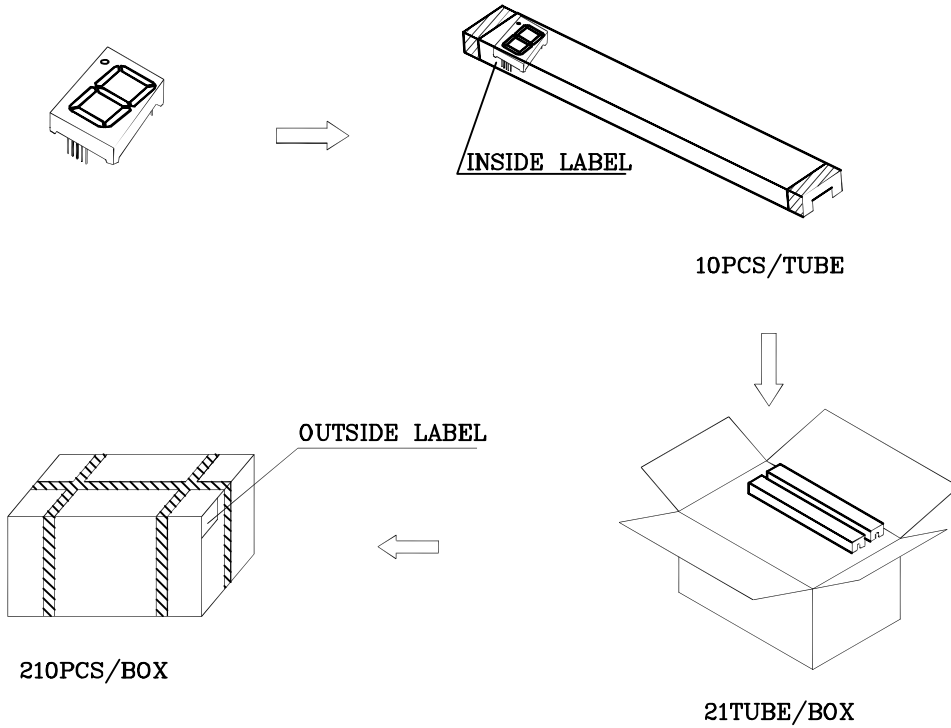

Inside Label On IC-tube

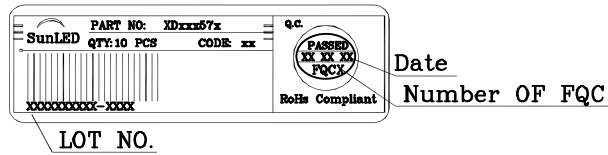

Outside Label On Box

