

Features

- Low power consumption
- Robust package
- I.C. Compatible
- Standard configuration: Gray face w/ white segments
- Optional black face provides superior color contrast
- RoHS Compliant

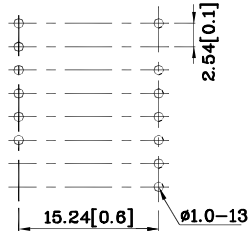

RECOMMENDED PCB LAYOUT



Package Schematics

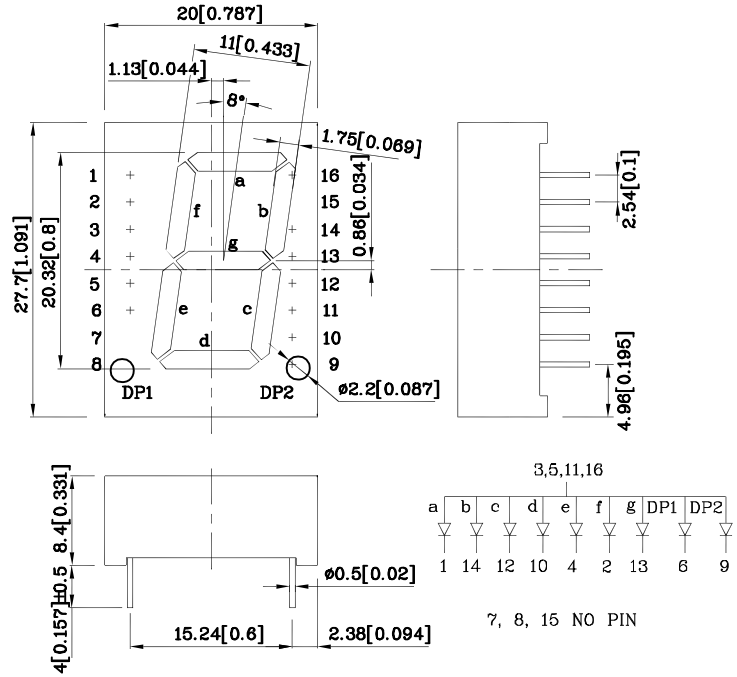

Notes:

1. All dimensions are in millimeters (inches), Tolerance is $\pm 0.25(0.01)$ unless otherwise noted.
2. Specifications are subject to change without notice.

| Absolute Maximum Ratings ($T_A=25^\circ\text{C}$) | | UR (GaAsP/GaP) | Unit |
|--|-----------------------|-------------------|------|
| Reverse Voltage | V_R | 5 | V |
| Forward Current | I_F | 30 | mA |
| Forward Current (Peak) 1/10 Duty Cycle 0.1ms Pulse Width | i_{FS} | 160 | mA |
| Power Dissipation | P_D | 75 | mW |
| Operating Temperature | T_A | -40 ~ +85 | °C |
| Storage Temperature | T_{stg} | -40 ~ +85 | |
| Lead Solder Temperature [2mm Below Package Base] | 260°C For 3-5 Seconds | | |

| Operating Characteristics ($T_A=25^\circ\text{C}$) | | UR (GaAsP/GaP) | Unit |
|--|-----------------|-------------------|---------------|
| Forward Voltage (Typ.) ($I_F=10\text{mA}$) | V_F | 1.9 | V |
| Forward Voltage (Max.) ($I_F=10\text{mA}$) | V_F | 2.5 | V |
| Reverse Current (Max.) ($V_R=5\text{V}$) | I_R | 10 | μA |
| Wavelength of Peak Emission (Typ.) ($I_F=10\text{mA}$) | λ_P | 627 | nm |
| Wavelength of Dominant Emission (Typ.) ($I_F=10\text{mA}$) | λ_D | 625 | nm |
| Spectral Line Full Width At Half-Maximum (Typ.) ($I_F=10\text{mA}$) | $\Delta\lambda$ | 45 | nm |
| Capacitance (Typ.) ($V_F=0\text{V}$, $f=1\text{MHz}$) | C | 15 | pF |

| Part Number | Emitting Color | Emitting Material | Luminous Intensity ($I_F=10\text{mA}$) ucd | Wavelength nm λ_P | Description | |
|-------------|----------------|-------------------|--|---------------------------------|-------------|-------------------------------------|
| | | | min. | typ. | | |
| XDUR20A-A | Red | GaAsP/GaP | 3600 | 7990 | 627 | Common Anode, Rt.&Lt. Hand Decimal. |

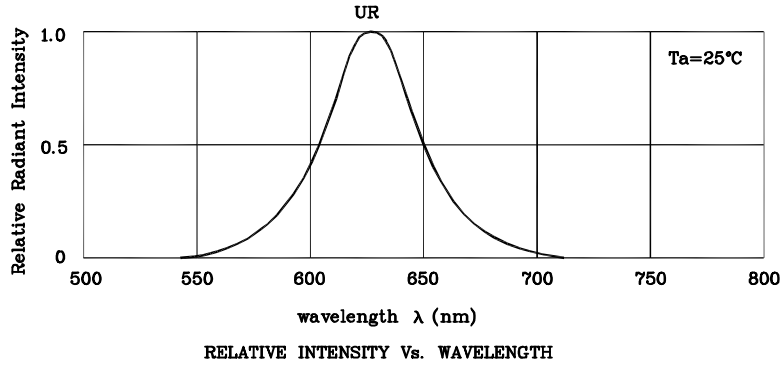

❖ UR

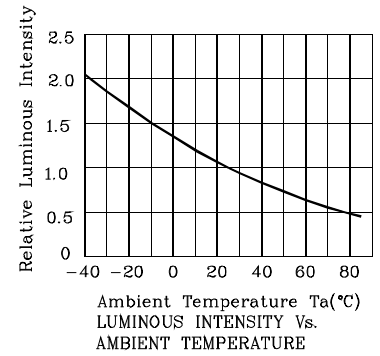
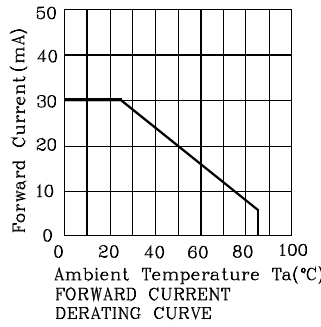
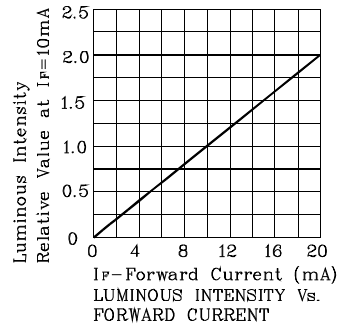
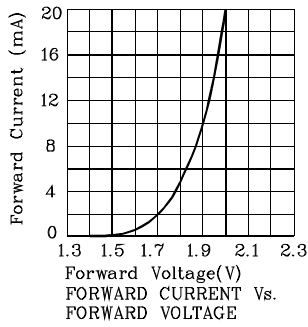

Wave Soldering Profile for Thru-Hole Products (Pb-Free Components)

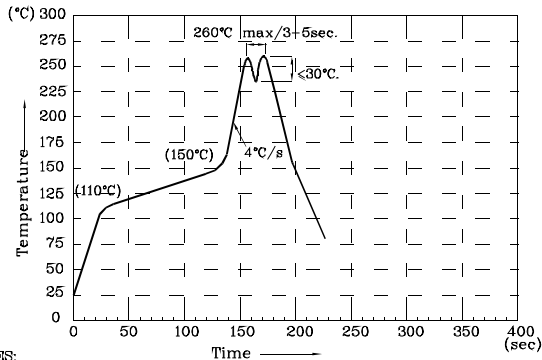

- NOTES:
1. Recommend the wave temperature 245°C~260°C. The maximum soldering temperature should be less than 260°C.
 2. Do not apply stress on epoxy resins when temperature is over 85°C.
 3. The soldering profile apply to the lead free soldering (Sn/Cu/Ag alloy).
 4. During wave soldering, the PCB top-surface temperature should be kept below 105°C.
 5. No more than once.

Remarks:

If special sorting is required (e.g. binning based on forward voltage, luminous intensity / luminous flux, or wavelength), the typical accuracy of the sorting process is as follows:

1. Wavelength: +/-1nm
2. Luminous Intensity / Luminous Flux: +/-15%
3. Forward Voltage: +/-0.1V

Note: Accuracy may depend on the sorting parameters.

PACKING & LABEL SPECIFICATIONS

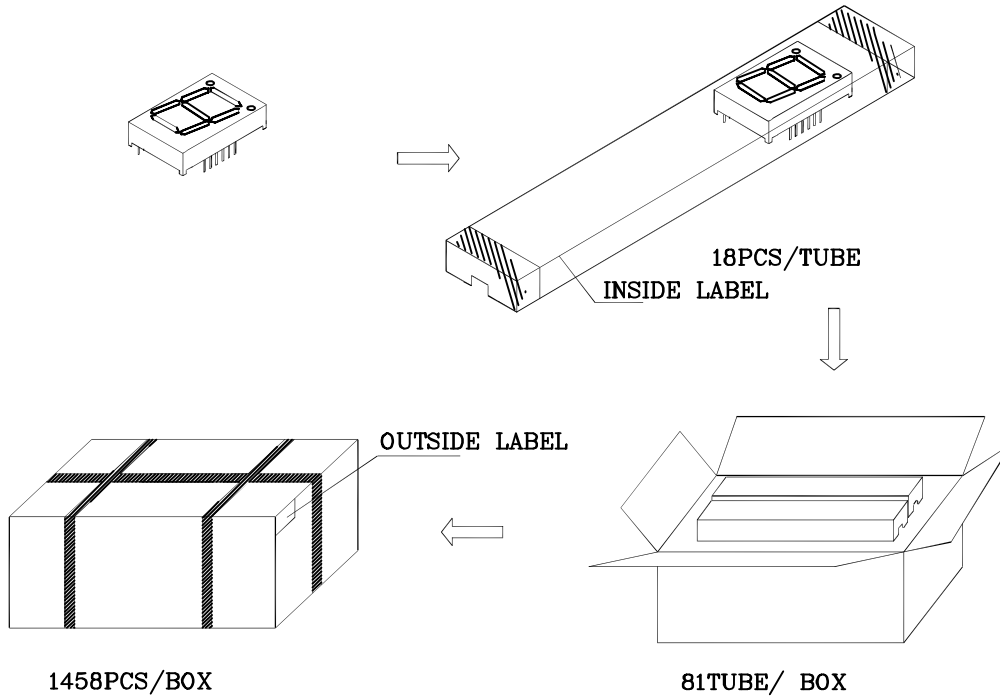

Inside Label On IC-tube

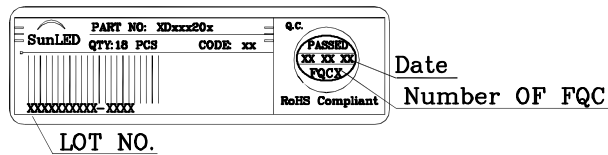

Outside Label On Box

