

**Features**

- Low power consumption
- Robust package
- I.C. Compatible
- Standard configuration: Gray face w/ white segments
- Optional black face provides superior color contrast
- RoHS Compliant

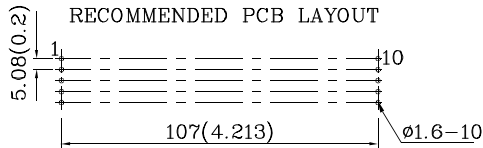

**Package Schematics**

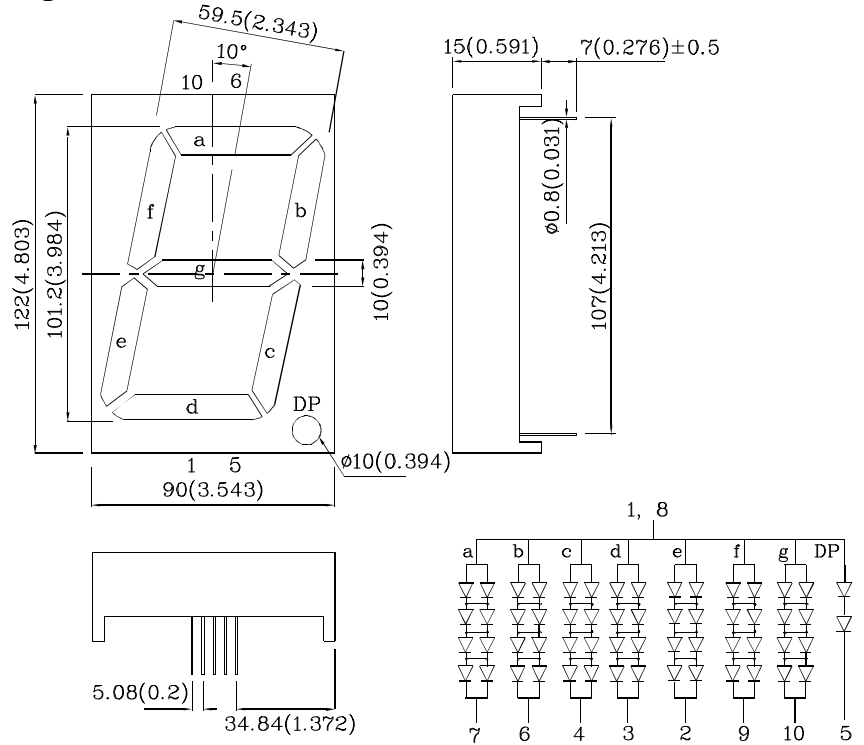

**Notes:**

1. All dimensions are in millimeters (inches), Tolerance is  $\pm 0.25(0.01)$  unless otherwise noted.
2. Specifications are subject to change without notice.

Absolute Maximum Ratings ( $T_A=25^\circ\text{C}$ )		UG (GaP)	Unit
Reverse Voltage Per Segment or (Dp)	$V_R$	5 (5)	V
Forward Current Per Segment or (Dp)	$I_F$	50 (25)	mA
Forward Current (Peak) Per Segment or (Dp) 1/10 Duty Cycle 0.1ms Pulse Width	$i_{FS}$	280 (140)	mA
Power Dissipation Per Segment or (Dp)	$P_D$	500 (125)	mW
Operating Temperature	$T_A$	-40 ~ +85	°C
Storage Temperature	$T_{stg}$	-40 ~ +85	
Lead Solder Temperature [2mm Below Package Base]	260°C For 3-5 Seconds		

Operating Characteristics ( $T_A=25^\circ\text{C}$ )		UG (GaP)	Unit
Forward Voltage (Typ.) Per Segment or (Dp) ( $I_F=10\text{mA}$ )	$V_F$	8 (4.0)	V
Forward Voltage (Max.) Per Segment or (Dp) ( $I_F=10\text{mA}$ )	$V_F$	10 (5.0)	V
Reverse Current (Max.) Per Segment or (Dp) ( $V_R=5\text{V}$ )	$I_R$	20 (10)	$\mu\text{A}$
Wavelength of Peak Emission (Typ.) ( $I_F=10\text{mA}$ )	$\lambda_P$	565	nm
Wavelength of Dominant Emission (Typ.) ( $I_F=10\text{mA}$ )	$\lambda_D$	568	nm
Spectral Line Full Width At Half-Maximum (Typ.) ( $I_F=10\text{mA}$ )	$\Delta\lambda$	30	nm
Capacitance (Typ.) ( $V_F=0\text{V}$ , $f=1\text{MHz}$ )	C	15	pF

Part Number	Emitting Color	Emitting Material	Luminous Intensity ( $I_F=10\text{mA}$ ) ucd	Wavelength nm $\lambda_P$	Description
			min.	typ.	
XDUG100A-A	Green	GaP	14000	35990	565 Common Anode, Rt. Hand Decimal.

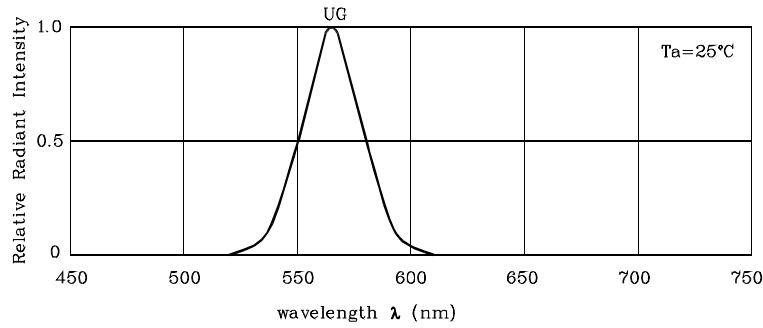

RELATIVE INTENSITY Vs. WAVELENGTH

❖ UG

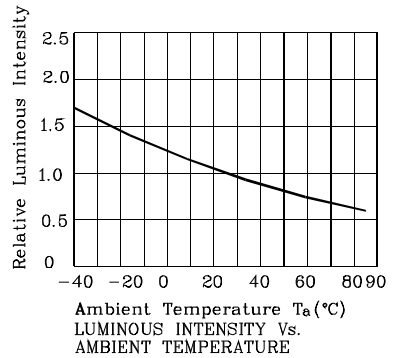
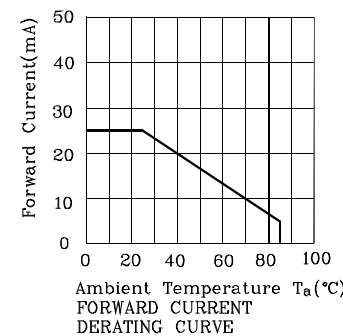
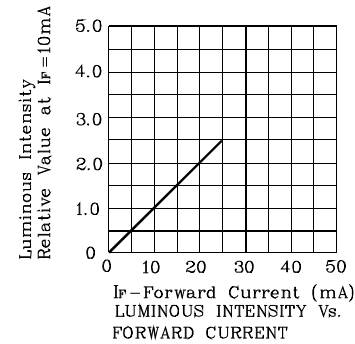
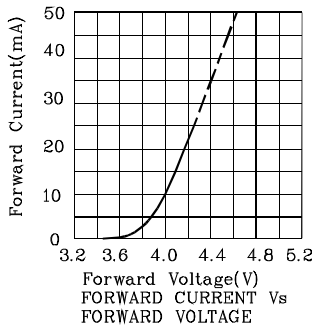
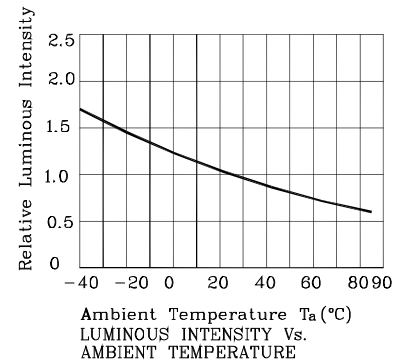
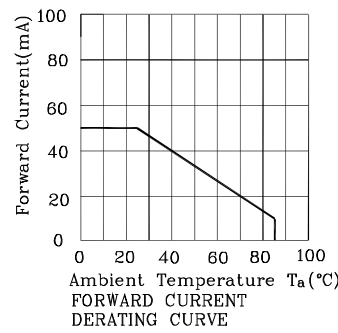
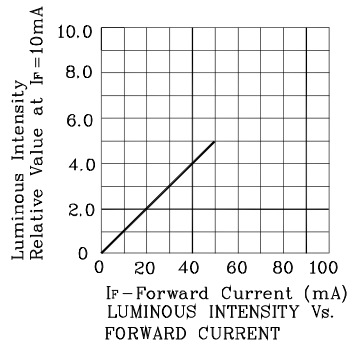
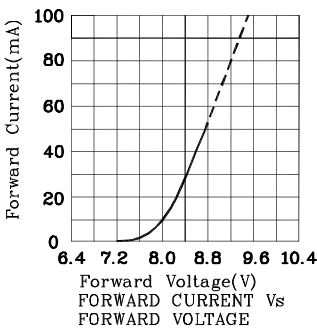

Wave Soldering Profile for Thru-Hole Products (Pb-Free Components)

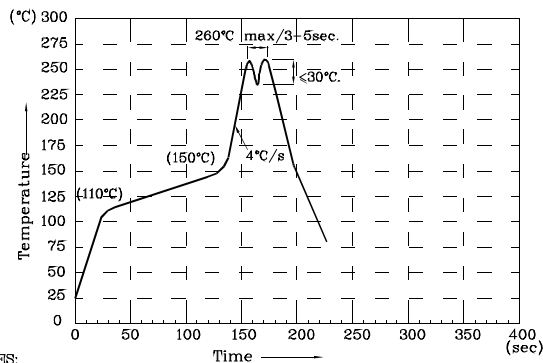

- NOTES:
1. Recommend the wave temperature 245°C~260°C. The maximum soldering temperature should be less than 260°C.
  2. Do not apply stress on epoxy resins when temperature is over 85°C.
  3. The soldering profile apply to the lead free soldering (Sn/Cu/Ag alloy).
  4. During wave soldering, the PCB top-surface temperature should be kept below 105°C.
  5. No more than once.

Remarks:

If special sorting is required (e.g. binning based on forward voltage, luminous intensity / luminous flux, or wavelength), the typical accuracy of the sorting process is as follows:

1. Wavelength: +/-1nm
2. Luminous Intensity / Luminous Flux: +/-15%
3. Forward Voltage: +/-0.1V

Note: Accuracy may depend on the sorting parameters.

PACKING & LABEL SPECIFICATIONS

